

Multilayer Chip Common Mode Filter– SDMM Series

Operating Temp. : -40°C~+85°C

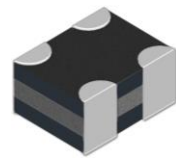

FEATURES

- Effective for suppressing common mode noise at high frequency
- Excellent solderability characteristics
- Small size & low profile
- Multilayer type SMD component based on LTCC technology

APPLICATIONS

- Common mode noise suppression of high speed differential signal lines, such as MIPI, MHL, HDMI in mobile phone, tablet PC, TV etc.

PRODUCT IDENTIFICATION

<u>SDMM</u>	<u>0806</u>	<u>U</u>	<u>-2</u>	<u>900</u>	<u>T</u>																		
①	②	③	④	⑤	⑥																		
①	②		⑤		③																		
<table border="1"> <tr><th colspan="2">Type</th></tr> <tr><td>SDMM</td><td>Multilayer Chip Common Mode Filter</td></tr> </table>	Type		SDMM	Multilayer Chip Common Mode Filter	<table border="1"> <tr><th colspan="2">External Dimensions (LxW) (mm)</th></tr> <tr><td>0605</td><td>0.65x0.50</td></tr> <tr><td>0806</td><td>0.85x0.65</td></tr> <tr><td>0906</td><td>0.90x0.68</td></tr> </table>		External Dimensions (LxW) (mm)		0605	0.65x0.50	0806	0.85x0.65	0906	0.90x0.68	<table border="1"> <tr><th colspan="2">Feature Type</th></tr> <tr><td>H</td><td>for High-Speed Differential Signal Lines</td></tr> <tr><td>U</td><td>for Ultra High Speed Differential Signal Lines</td></tr> </table>		Feature Type		H	for High-Speed Differential Signal Lines	U	for Ultra High Speed Differential Signal Lines	
Type																							
SDMM	Multilayer Chip Common Mode Filter																						
External Dimensions (LxW) (mm)																							
0605	0.65x0.50																						
0806	0.85x0.65																						
0906	0.90x0.68																						
Feature Type																							
H	for High-Speed Differential Signal Lines																						
U	for Ultra High Speed Differential Signal Lines																						
④	⑤		⑥																				
<table border="1"> <tr><th colspan="2">Number of Lines</th></tr> <tr><td>2</td><td>2 Lines</td></tr> <tr><td>3</td><td>3 Lines</td></tr> </table>	Number of Lines		2	2 Lines	3	3 Lines	<table border="1"> <tr><th colspan="2">Common Mode Impedance (Ω)</th></tr> <tr><th>Example</th><th>Nominal Value</th></tr> <tr><td>350</td><td>35</td></tr> <tr><td>900</td><td>90</td></tr> </table>		Common Mode Impedance (Ω)		Example	Nominal Value	350	35	900	90	<table border="1"> <tr><th colspan="2">Packing</th></tr> <tr><td>T</td><td>Tape & Reel</td></tr> </table>		Packing		T	Tape & Reel	
Number of Lines																							
2	2 Lines																						
3	3 Lines																						
Common Mode Impedance (Ω)																							
Example	Nominal Value																						
350	35																						
900	90																						
Packing																							
T	Tape & Reel																						

SHAPE DIMENSIONS AND LAND-PATTERN

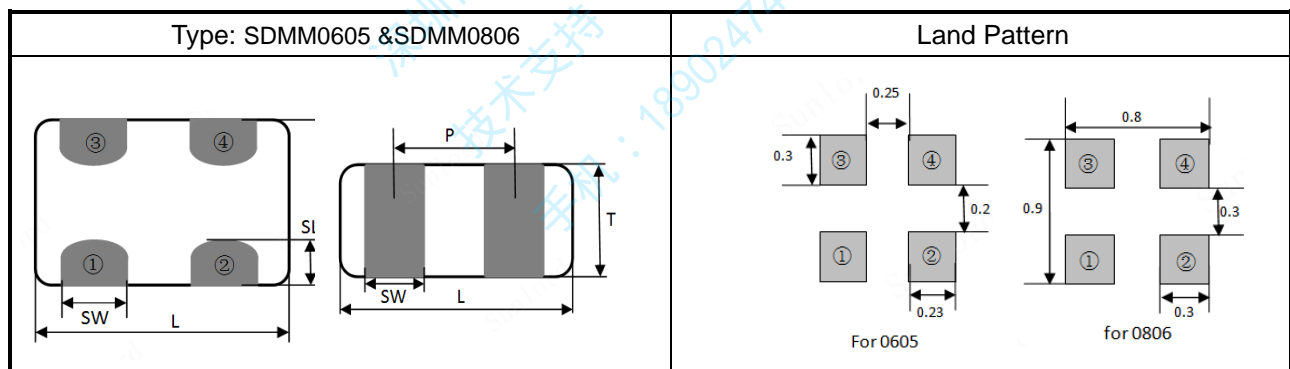

SHAPE DIMENSIONS AND LAND-PATTERN

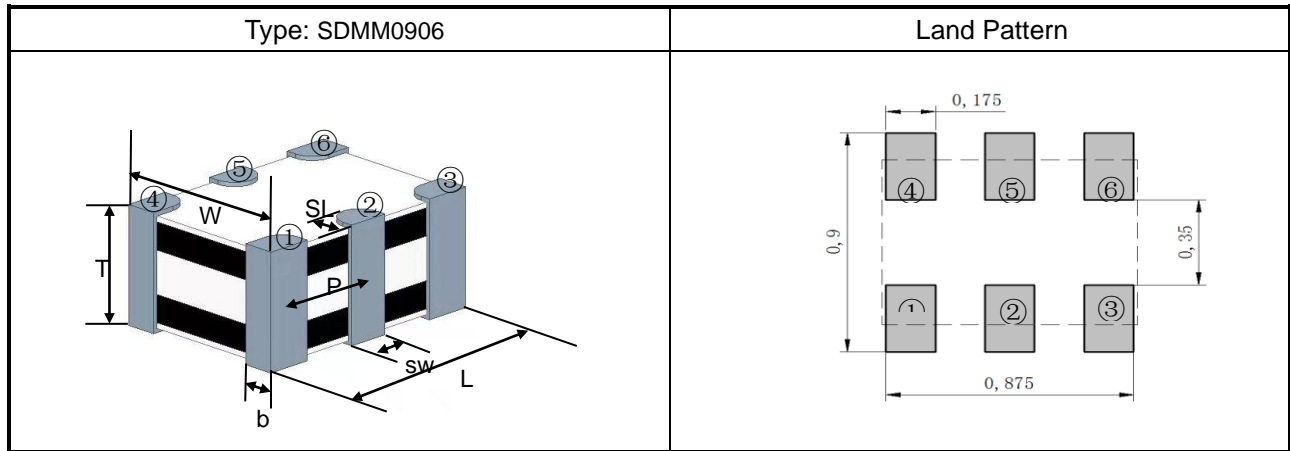

Unit: mm

Type	L	W	T	SL	SW	P	b
SDMM0605	0.65±0.05	0.50±0.05	0.30±0.05	0.12±0.10	0.15±0.10	0.40±0.10	/
SDMM0806	0.85±0.05	0.65±0.05	0.40±0.05	0.20+0.05/-0.10	0.27±0.05	0.50±0.05	/
SDMM0906	0.90±0.05	0.68±0.05	0.40±0.05	0.12±0.10	0.15±0.10	0.35±0.10	SL

EQUIVALENT CIRCUIT



SPECIFICATIONS

SDMM0605H Series

Part Number	Common Mode Impedance @ 100MHz	Max. DC Resistance	Max. Rated Current	Rated Voltage	Withstand Voltage	Min. Insulation Resistance
Units	Ω	Ω	mA	Volts	Volts	MΩ
Symbol	Z	DCR	I _r	VDC	V _p	IR
SDMM0605H-2-900T	90±20%	5.0	100	5	12.5	100

SDMM0906H Series

Part Number	Common Mode Impedance @ 100MHz	Max. DC Resistance	Max. Rated Current	Withstand Voltage	Min. Insulation Resistance
Units	Ω	Ω	mA	Volts	MΩ
Symbol	Z	DCR	I _r	V _p	IR
SDMM0906H-3-300T	30±20%	4.0	50	12.5	100

SPECIFICATIONS

SDMM0605U Series

Part Number	Common Mode Impedance @ 100MHz	Max. DC Resistance	Max. Rated Current	Rated Voltage	Withstand Voltage	Min. Insulation Resistance
Units	Ω	Ω	mA	Volts	Volts	M Ω
Symbol	Z	DCR	I _r	VDC	V _p	IR
SDMM0605U-2-120T	12±5	2.5	50	5	12.5	100
SDMM0605U-2-250T	25±20%	3.5	50	5	12.5	100

SDMM0806U Series

Part Number	Common Mode Impedance @ 100MHz	Max. DC Resistance	Max. Rated Current	Min. Insulation Resistance	Cutoff Frequency (typ.)
Units	Ω	Ω	mA	M Ω	GHz
Symbol	Z	DCR	I _r	IR	f ₀
SDMM0806U-2-120T	12±5	2.5	130	100	>8
SDMM0806U-2-350T	35±20%	3.5	100	100	>6
SDMM0806U-2-470T	47±20%	4.0	100	100	6
SDMM0806U-2-900T	90±20%	4.5	100	100	3.5

Note: Absolute maximum long term direct-current voltage between D+ and D- of differential lines: DC 1.5V

SDMM0806U-J01 Series

Part Number	Common Mode Impedance @ 100MHz	Max. DC Resistance	Max. Rated Current	Rated Voltage	Withstand Voltage	Min. Insulation Resistance
Units	Ω	Ω	mA	Volts	Volts	M Ω
Symbol	Z	DCR	I _r	VDC	V _p	IR
SDMM0806U-2-120TJ01	12±5	2.5	130	1.5	12.5	100
SDMM0806U-2-900TJ01	90±20%	4.5	100	1.5	12.5	100

*Note: V_{dcc} is a long term direct-current voltage difference which between D+ and D- of differential lines.

ELECTRICAL CHARACTERISTICS

SDMM0605H Series

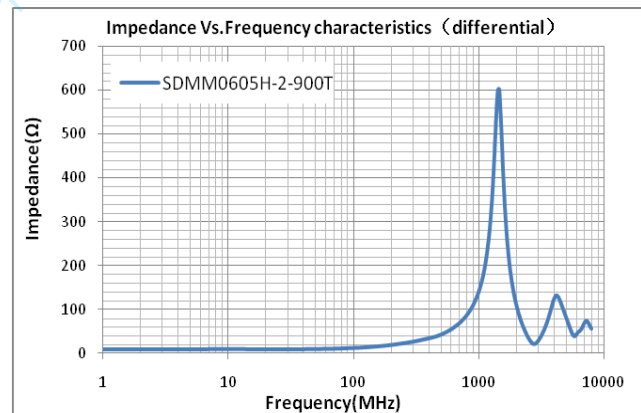
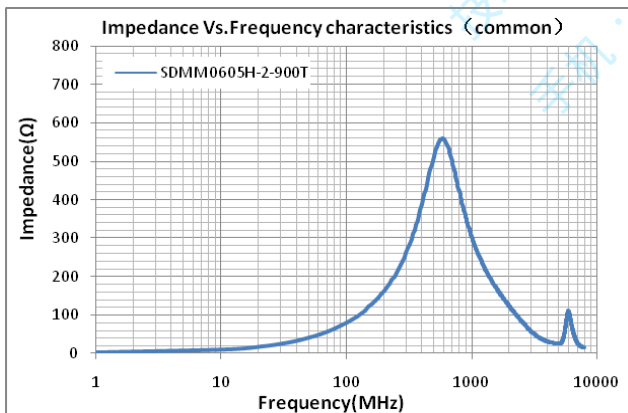

ELECTRICAL CHARACTERISTICS

SDMM0605H Series

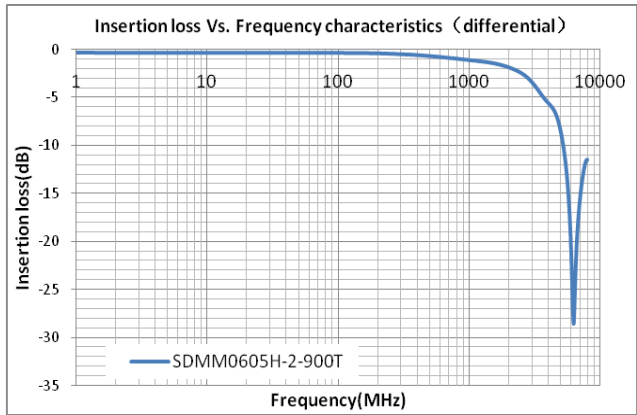
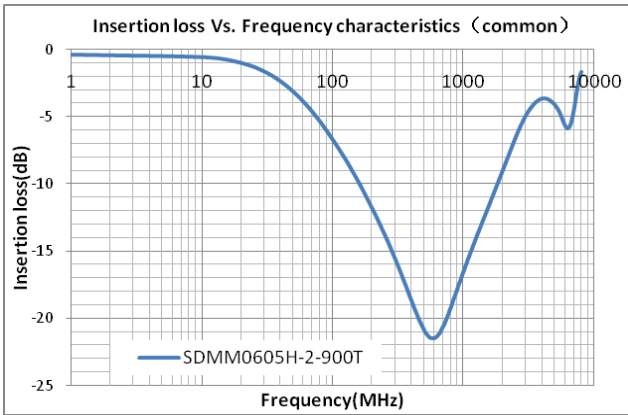

SDMM0906H Series

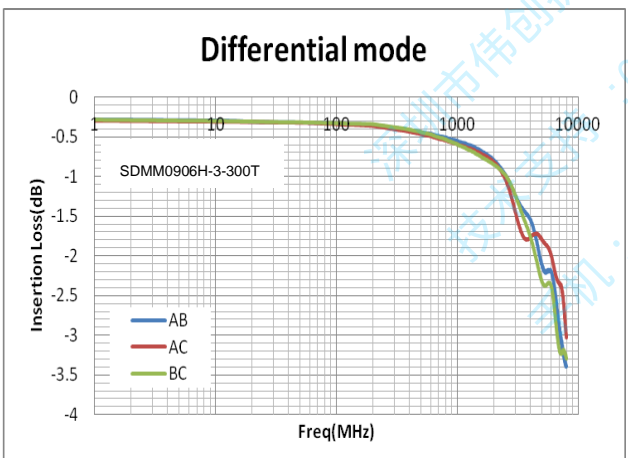
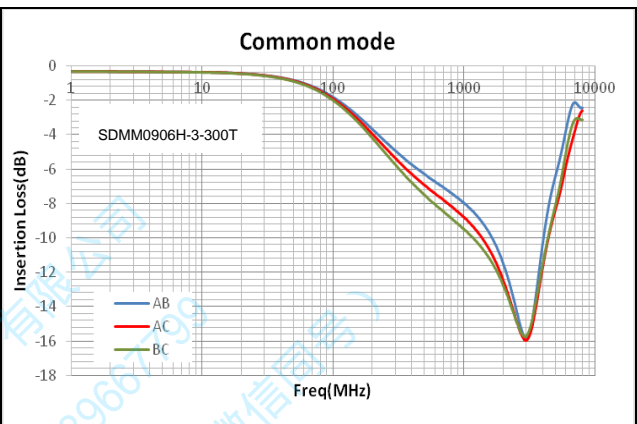
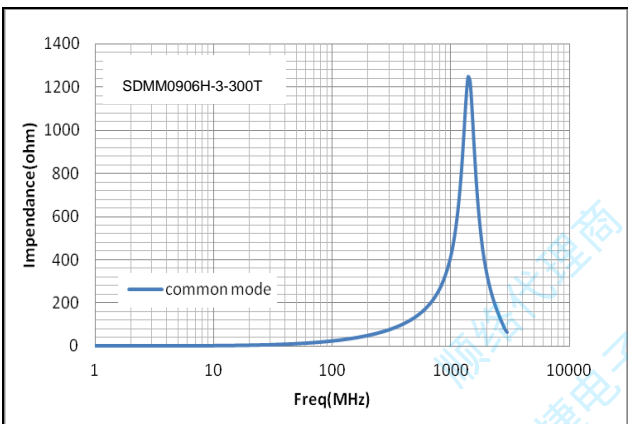

ELECTRICAL CHARACTERISTICS

SDMM0605U Series

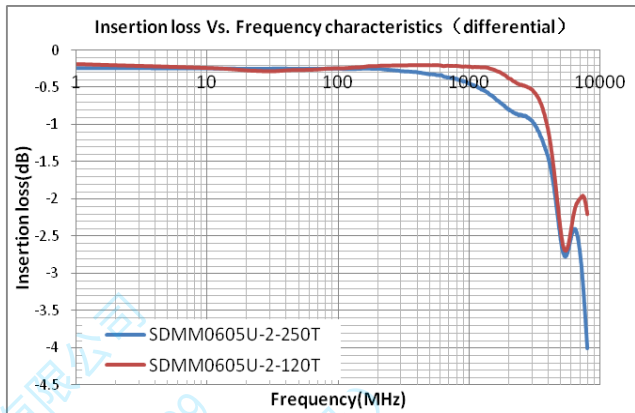
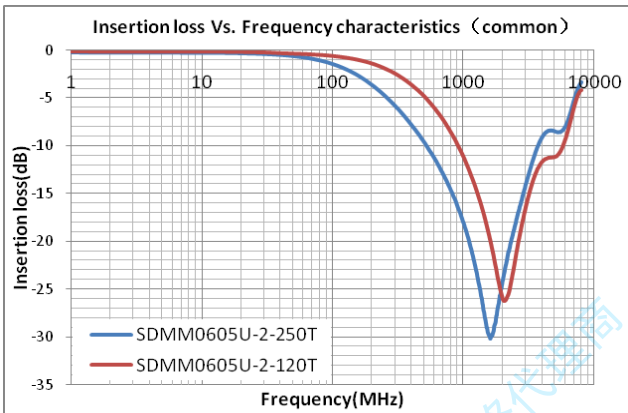
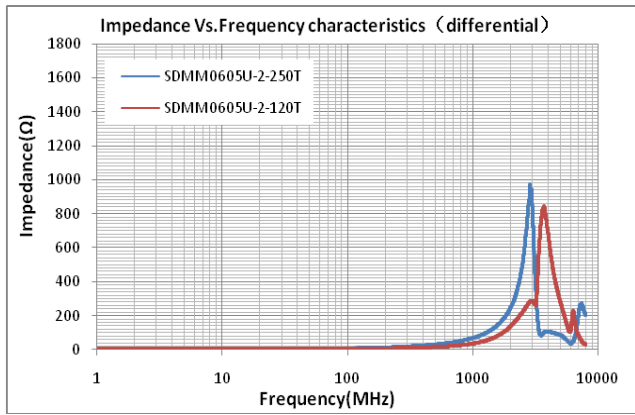
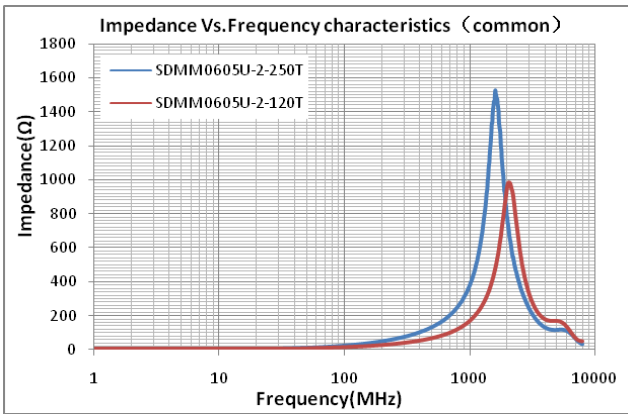

SDMM0806U Series

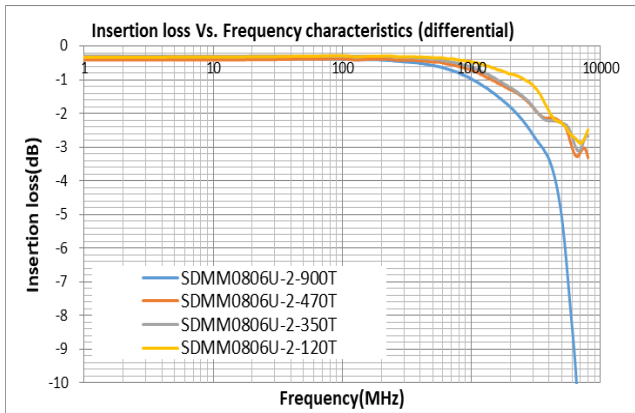
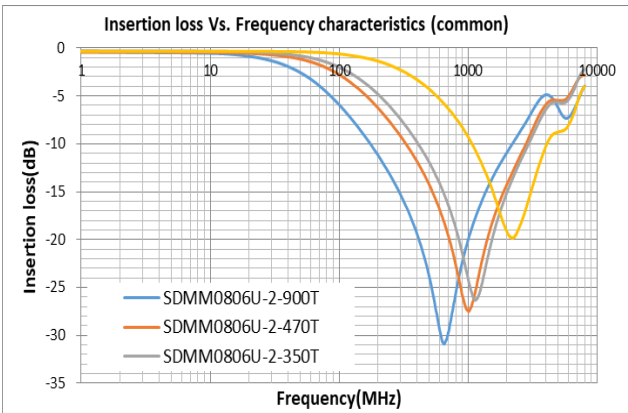
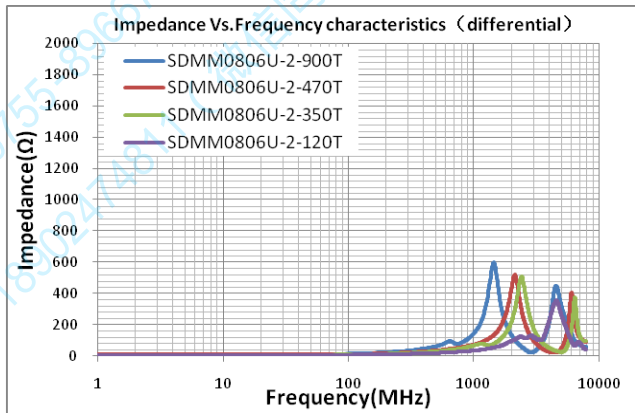
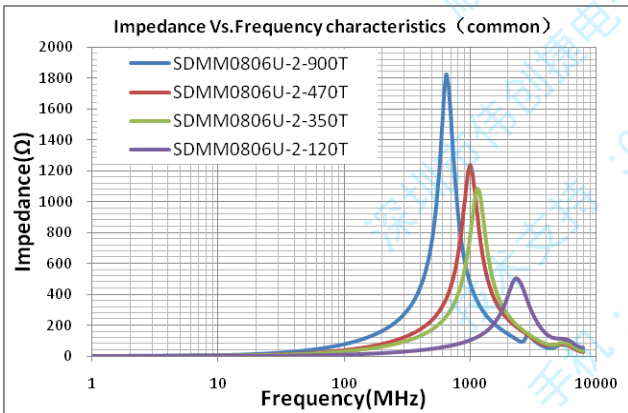

ELECTRICAL CHARACTERISTICS

SDMM0806U-J01 Series

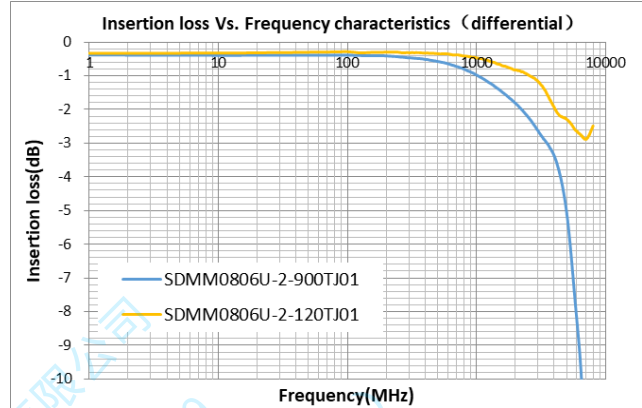
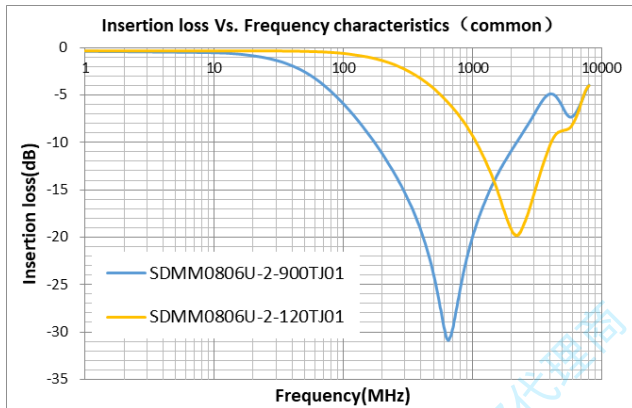
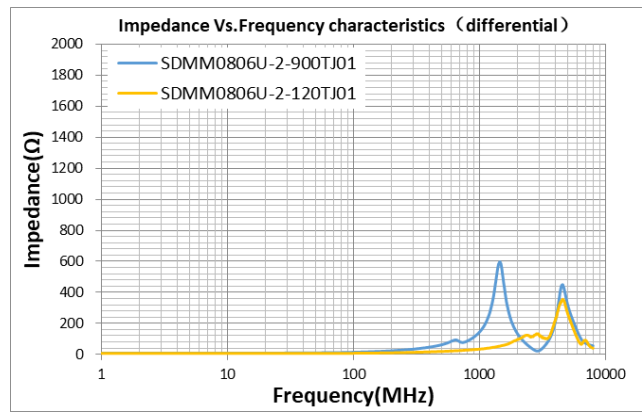
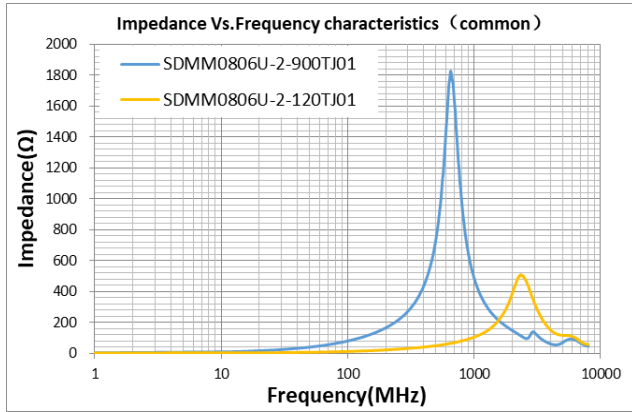

顺络代理
深圳市伟创捷电子有限公司
技术支持 : 0755-89667799
手机 : 18902474811 (微信同号)